

HOW TO MEASURE

- Measure the height to the bottom of door sill.
- The top of the step should be approximately 7-1/2" below the top of the door sill.
- Make sure you have enough room for the depth of the step.

FINISHES



Standard Finish



Broom Finish



Textured Shale Finish



Random Stone Finish



A T T E N T I O N

CARE OF STEPS

- Salt or chemicals are harmful to any concrete surface and should not be used for removal of ice or snow. Use of any such product will mar the marble-like surface of your steps.
- Sealer should be applied yearly to preserve the colour of stamped steps.



Available
in granite
finish



- 4' width
- hollow core
- 2 rise block available

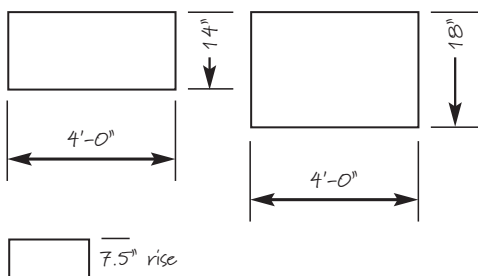

MODULAR PORCH UNITS

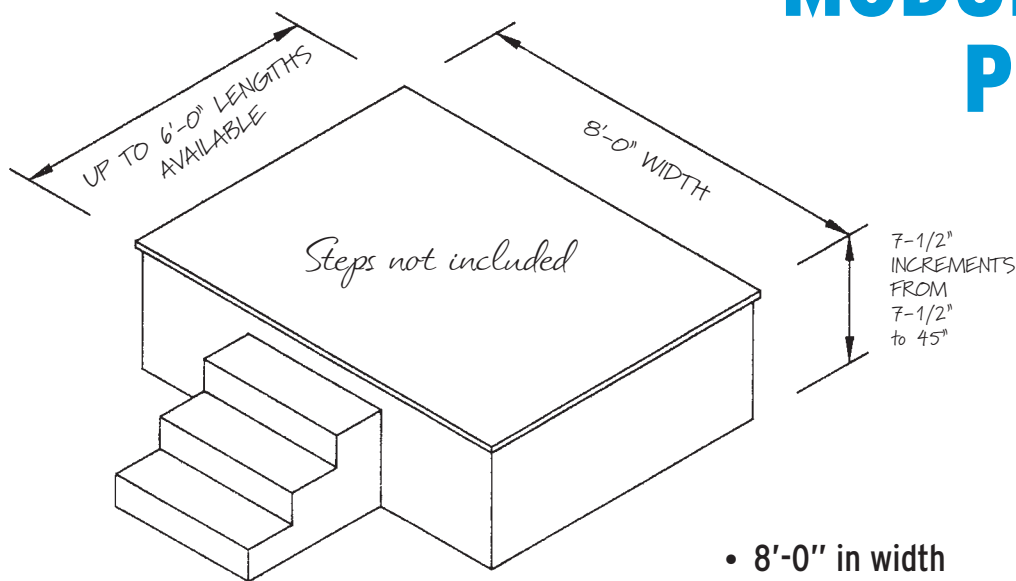

Available
finishes...

- textured shale
- random stone
- broom

- 8'-0" in width
- up to 6'-0" lengths available
- available in 7-1/2" rises, increments from 7-1/2" to 45"

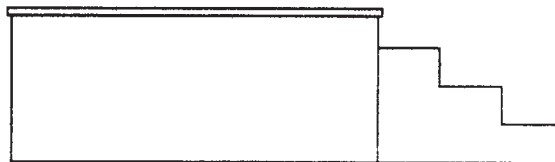
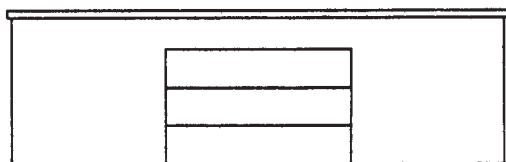

S T A C K I N G S T E P S

- 3', 4', 6' and 8' widths
- 1 - 5 risers
- separate units

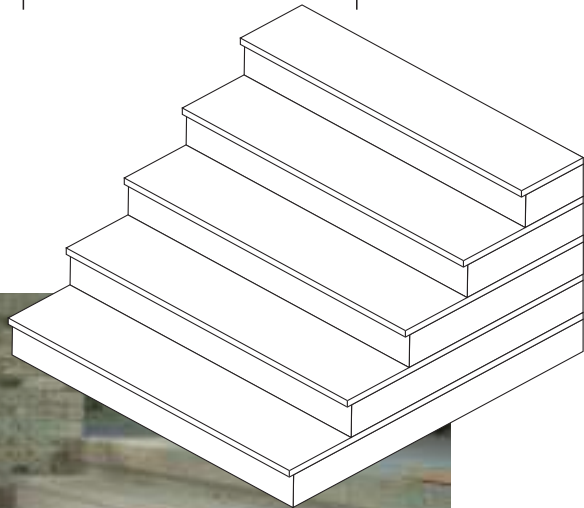
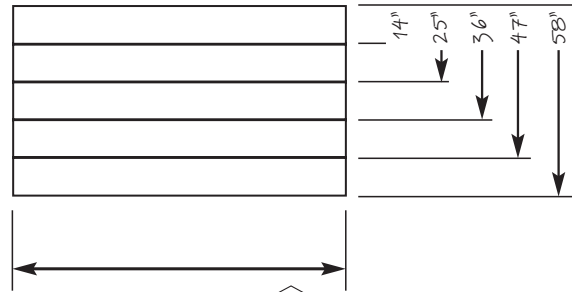
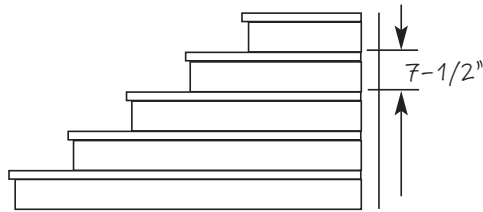

Available finishes...

- textured shale
- random stone
- broom





STEPS ONLY

- 1 to 7 risers
- in 3, 4, 5 or 6 foot widths

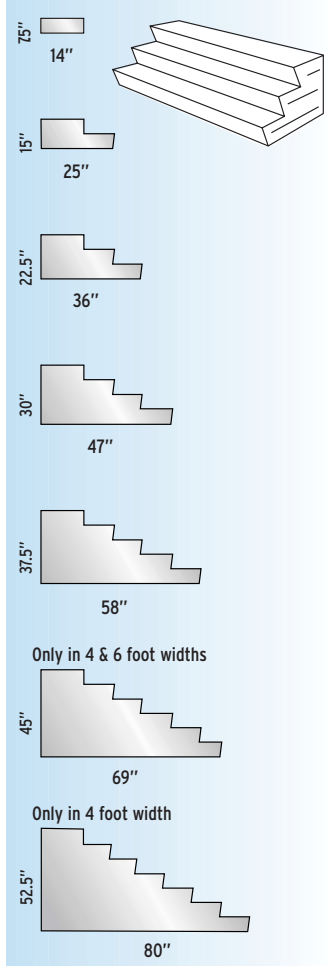

STEPS & 36" PORCH

- 1 to 7 risers
- in 3, 4 or 5 foot widths

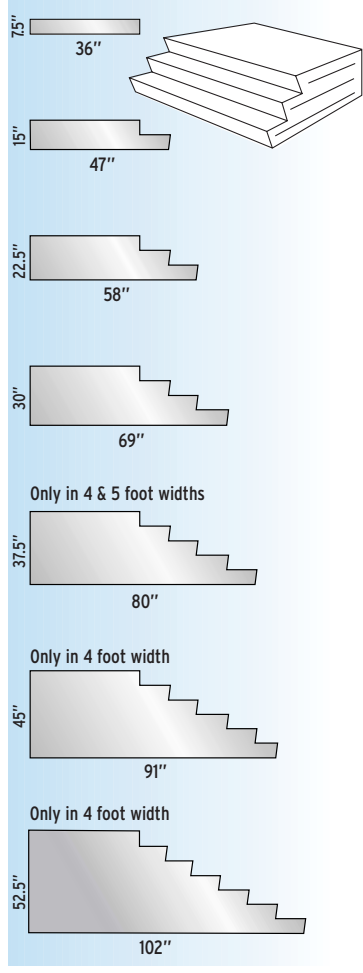

STEPS & 48" PORCH

- 1 to 7 risers
- in 4, 5 or 6 foot widths

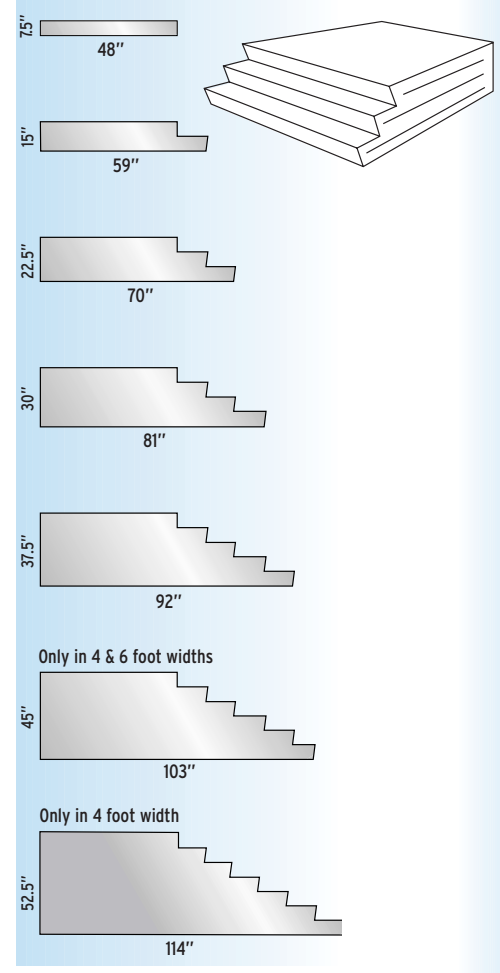

**SIDE ENTRANCE STEPS
48" OR 60" PORCH**



- 3' width with 2-4 risers on 48" porch
- 4' width with 2-7 risers on 48" or 60" porch

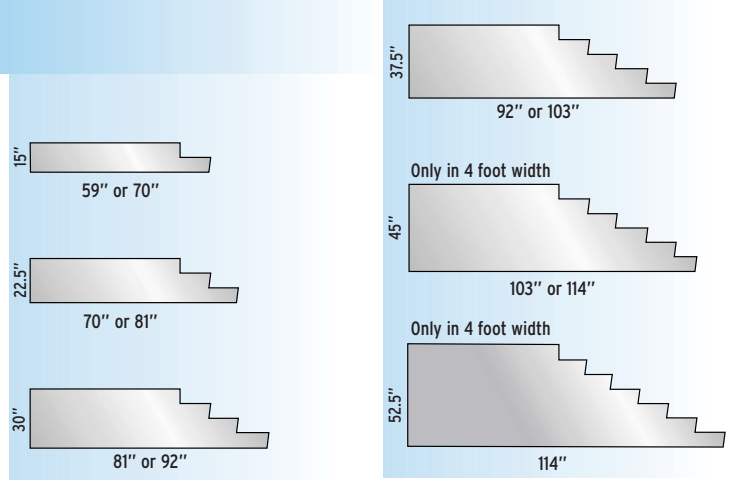
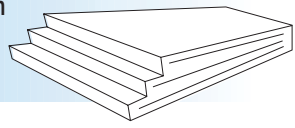

Items on this page available in standard finish only.